



VITA 62 Power Supply

VIT270wxx600yzzz

VITA 62 DC-DC Converter

Features & Benefits

- OpenVPX™ – VITA 62
- 180 – 420V input voltage range
- 600W output power
- 3U OpenVPX power supply
- Conduction cooled
- 6 outputs
- I²C monitoring and control
- Remote voltage sense: VS1, VS2, VS3
- Parallel operation capable with proprietary wireless current sharing
- Overcurrent, overvoltage and overtemperature protections
- IPC 610 class 3
- No aluminum electrolytic capacitors
- Enable, inhibit, system reset and power fail controls
- Military standard compliance: ^[a]
 - MIL-STD-704F
 - MIL-STD-461F
 - MIL-STD-810G

Typical Applications

- VPX power modules
- Avionics
- Shipborne electronics

Product Description

The Vicor VITA 62 power supply is a COTs power supply that is designed for 3U OpenVPX systems. The module utilizes Vicor proprietary technology to enable high efficiency and power density for this highly rugged, conduction-cooled model.

Up to four power supplies can be paralleled to increase output power capability of VS1, VS2, VS3 outputs with proprietary wireless current sharing. Conventional current-share pins are eliminated. Current share accuracy is $\pm 1\%$.

^[a] See detailed specifications

Note: Product images may not highlight current product markings.

Connector Pin Configuration

ROWS	POWER			SIGNAL								POWER					
				1	2	3	4	5	6	7	8						
D	P1	P2	LP1										P3	P4	P5	LP2	P6
C																	
B																	
A																	

3U P0 Connector

Note: See mechanical drawing on page 28 for connector information.

Connector Pin Descriptions

Pin	Function / Name	Description
P1	-DC_IN	V _{IN-}
P2	+DC_IN	V _{IN+}
LP1	CHASSIS	Chassis
A1	No Connection	
B1	No Connection	
C1	No Connection	
D1	No Connection	
A2	No Connection	
B2	FAIL*	When any of the output is not within specification, FAIL* signal will be driven low to indicate a failure
C2	INHIBIT*	Input control signal as defined in VITA 62, referenced to SIGNAL_RETURN
D2	ENABLE*	Input control signal as defined in VITA 62, referenced to SIGNAL_RETURN
A3	No Connection	
B3	+12V _{AUX}	+12V auxiliary output voltage
C3	No Connection	
D3	No Connection	
A4, B4, C4, D4	+3.3V _{AUX}	+3.3V auxiliary output voltage
A5	*GA0	Geographical address defined by VITA 46.11
B5	*GA1	Geographical address defined by VITA 46.11
C5	SM0 (I ² C Clock)	Primary I ² C communication bus
D5	SM1 (I ² C Data)	
A6	I ² C Clock	Redundant I ² C communication bus (optional feature pending)
B6	I ² C Data	
C6	-12V _{AUX}	-12V auxiliary output voltage
D6	SYS_RESET*	System Reset is actively low. It will float when all outputs are within specification
A7	No Connection	
B7	No Connection	
C7	No Connection	
D7	SIGNAL_RETURN	Ground pin for control signals
A8	+12V _{SENSE}	VS1 sense, shall be connected at point-of-load or on the backplane to corresponding voltage output
B8	+3.3V _{SENSE}	VS2 sense, shall be connected at point-of-load or on the backplane to corresponding voltage output
C8	+5V _{SENSE}	VS3 sense, shall be connected at point-of-load or on the backplane to corresponding voltage output
D8	SENSE_RETURN	Shall be connected to POWER_RETURN either remotely or at the backplane connector
P3	+5V _{MAIN}	VS3
P4, P5	POWER_RETURN	Common output voltage return pin
LP2	+3.3V _{MAIN}	VS2
P6	+12V _{MAIN}	VS1

Part Ordering Information

Part Number	Product Grade	Conformal Coating	Factory-Configured Options
VIT270H3U600C02	H = -40 to 85°C	C = Coated	002 = Parallelable

Absolute Maximum Ratings

The absolute maximum ratings below are stress ratings only. Operation at or beyond these maximum ratings can cause permanent damage to the device.

Parameter	Comments	Min	Max	Unit
Total Output Power	Combined outputs for all rails		600	W
Input Voltage	+IN to -IN	-0.5	460	V
Operating Temperature	Measured at card edge	-40	85	°C
Storage Temperature		-40	125	
Isolation Voltage IN to OUT			1000	V _{DC}
Isolation Voltage IN to CASE			1000	V _{DC}
Isolation Voltage OUT to CASE			100	V

Electrical Characteristics

All data at nominal line and nominal load unless otherwise specified.

Attribute	Symbol	Conditions / Notes	Min	Typ	Max	Unit
Overall System Characteristics						
System Efficiency		Nominal line, 20% aggregate loads		83		%
		Nominal line, 50% aggregate loads		89		
		Nominal line, 100% aggregate loads		89		
Power Input Characteristics						
Operating Input Voltage Range		Full load	180	270	420	V
Transient					450	V
Input Current (No Load)		270V Input, enable asserted (input on), inhibit de-asserted (output on)		30	75	mA
Inrush Current		Peak no load, high line		1.4	5	A
Main Outputs						
+12V Output						
Output Voltage Set Point		Nominal line, nominal load	11.85	12	12.15	V
Line Regulation		50% load			0.2	%
Load Regulation		Nominal line			2	%
Output Ripple / Noise (Peak-to-Peak)		Nominal line over load range, 20MHz BW		50.4	120	mV _{p-p}
Maximum Capacitive Load		External			9000	μF
Output Current Range			0		40	A
Output Overvoltage Protection		See Table 8 for sensor threshold values				
Output Overcurrent Protection		See Table 8 for sensor threshold values				
+5V Output						
Output Voltage Set Point		Nominal line, nominal load	4.9	5.0	5.1	V
Line Regulation		50% load			0.15	%
Load Regulation		Nominal line			2	%
Output Ripple / Noise (Peak-to-Peak)		Nominal line over load range, 20MHz BW		20	50	mV _{p-p}
Maximum Capacitive Load		External			9000	μF
Output Current Range			0		30	A
Output Overvoltage Protection		See Table 8 for sensor threshold values				
Output Overcurrent Protection		See Table 8 for sensor threshold values				

Electrical Characteristics (Cont.)

All data at nominal line and nominal load unless otherwise specified.

Attribute	Symbol	Conditions / Notes	Min	Typ	Max	Unit
Main Outputs (Cont.)						
+3.3V Output						
Output Voltage Set Point		Nominal line, nominal load	3.25	3.3	3.45	V
Line Regulation		50% load			0.15	%
Load Regulation		Nominal line			4.5	%
Output Ripple / Noise (Peak-to-Peak)		Nominal line over load range, 20MHz BW		20	50	mV _{p-p}
Maximum Capacitive Load		External			9000	μF
Output Current Range			0		20	A
Output Overvoltage Protection		See Table 8 for sensor threshold values				
Output Overcurrent Protection		See Table 8 for sensor threshold values				
Auxilliary Outputs						
-12V Output						
Output Voltage Set Point		Nominal line, nominal load	-11.8	-12.00	-12.1	V
Line Regulation		50% load			0.15	%
Load Regulation		Nominal line		1.66	2.0	%
Output Ripple / Noise (Peak-to-Peak)		Nominal line over load range, 20MHz BW		15	120	mV _{p-p}
Output Current Range			0		1.2	A
Output Overcurrent Protection		See Table 8 for sensor threshold values				
+12V Output						
Output Voltage Set Point			11.9	12.00	12.1	V
Line Regulation		50% load			0.1	%
Load Regulation		Nominal line		1.21	1.25	%
Output Ripple / Noise (Peak-to-Peak)		Nominal line over load range, 20MHz BW		30	120	mV _{p-p}
Output Current Range			0		1.2	A
Output Overcurrent Protection		See Table 8 for sensor threshold values				
+3.3V Output						
Output Voltage Set Point			3.2	3.3	3.4	V
Line Regulation		50% load			0.14	%
Load Regulation		Nominal line		2.0	2.5	%
Output Ripple / Noise (Peak-to-Peak)		Nominal line over load range, 20MHz BW			50	mV _{p-p}
Output Current Range			0		7	A
Output Overcurrent Protection		See Table 8 for sensor threshold values				

Signal Characteristics

All of the following plots are at nominal line and 600W aggregate load unless otherwise noted.

ENABLE*: Enable*								
<ul style="list-style-type: none"> The ENABLE* pin or control register bit enables and disables the +3.3V AUX output of the power supply. The ENABLE* pin has an internal pull-up to V_{CC} and is referenced to the Signal Return pin of the power supply. 								
Signal Type	State	Attribute	Symbol	Conditions / Notes	Min	Typ	Max	Unit
Digital Input	Any	ENABLE* Enable Threshold	V _{ENABLE-EN}				0.8	V
		ENABLE* Disable Threshold	V _{ENABLE-DIS}		2.0			V
		Internally Generated V _{CC}	V _{CC}		3.21	3.30	3.39	V
		ENABLE* Internal Pull-Up Resistance to V _{CC}	R _{ENABLE-INT}		49	51	52	kΩ
		ENABLE* Enable Debounce Delay	t _{D-EN-E}		3	5		ms
		ENABLE* Disable Debounce Delay	t _{D-EN-D}		3	5		ms

INHIBIT*: Inhibit*								
<ul style="list-style-type: none"> The INHIBIT* pin enables and disables all outputs except +3.3V_{AUX} if V_{ENABLE-EN} threshold has been met. The INHIBIT* pin has an internal pull up to V_{CC} and is referenced to the Signal Return pin of the power supply. 								
Signal Type	State	Attribute	Symbol	Conditions / Notes	Min	Typ	Max	Unit
Digital Input	Any	INHIBIT* Enable Threshold	V _{INHIBIT-EN}	Status register bit 4 should be 0 (default) for digital input control line to have priority	2.0			V
		INHIBIT* Disable Threshold	V _{INHIBIT-DIS}				0.8	V
		Internally Generated V _{CC}	V _{CC}		3.21	3.30	3.39	V
		INHIBIT* Internal Pull-Up Resistance to V _{CC}	R _{DISABLE-INT}		49	51	52	kΩ
		INHIBIT* Enable Debounce Delay after ENABLE*	t _{D-IN-E}		3	5		ms
		INHIBIT* Disable Debounce Delay	t _{D-IN-D}		3	5		ms
		Lockout Delay Between Consecutive INHIBIT* Enables	t _{D-IN-L}		3	5		ms

Signal Characteristics (Cont.)

All of the following plots are at nominal line and 600W aggregate load unless otherwise noted.

GA0*, GA1*: Geographical Address								
<ul style="list-style-type: none"> The GA0* and GA1* pins sets the I²C address of the power supply. Geographical address is set at start up and cannot be changed without a power cycle. The GA0* and GA1* pins have an internal pull-up to V_{CC} and is referenced to the Signal Return pin of the power supply. 								
Signal Type	State	Attribute	Symbol	Conditions / Notes	Min	Typ	Max	Unit
Digital Input	Start Up	Address Pins Low Threshold	V _{ADDR-L}				0.8	V
		Address Pins High Threshold	V _{ADDR-H}		2.0			V
		Internally Generated V _{CC}	V _{CC}		3.21	3.30	3.39	V
		ENABLE* Internal Pull-Up Resistance to V _{CC}	R _{ADDR-INT}		49	51	52	kΩ
		Address Pins Debounce Delay	t _{D-ADDR}		5			ms

FAIL*, SYSRESET* & LED								
<ul style="list-style-type: none"> The power supply has one two color LED located on the ejector edge of the power supply. The LED is either GREEN or RED depending on the state of operation. FAIL* and SYSRESET* lines are set with the LED. 								
Signal Type	State	Attribute	Symbol	Conditions / Notes	Min	Typ	Max	Unit
Outputs	Steady RED	SYSRESET*	V _{SYSRST}	Start up: input voltage operating threshold V _{UV-IN} < V _{IN} < V _{OV-IN} has been met; if steady RED persists for >100ms, a critical system fault has been detected during start up	0.0		0.8	V
		FAIL*	V _{FAIL}		0.0		0.8	V
	Blinking GREEN	SYSRESET*	V _{SYSRST}	>100ms after V _{UV-IN} < V _{IN} < V _{OV-IN} has been met; power supply is ready for use	2.0		3.5	V
		FAIL*	V _{FAIL}		2.0		3.5	V
	Steady GREEN	SYSRESET*	V _{SYSRST}	All outputs are OK and ENABLE* is pulled low	2.0		3.5	V
		FAIL*	V _{FAIL}		2.0		3.5	V
	Blinking RED	SYSRESET*	V _{SYSRST}	Power supply has encountered a OT, OV, UV, OC or critical system failure during operating	2.0		3.5	V
		FAIL*	V _{FAIL}		0.0		0.8	V
	Fast Blinking GREEN	None	-	SW priority is set by 0x55 status command	-	-	-	-
	Blinking Alternate GREEN/RED	None	-	Battle Override mode is enabled successfully by 0x55 status command	-	-	-	-

Application Characteristics

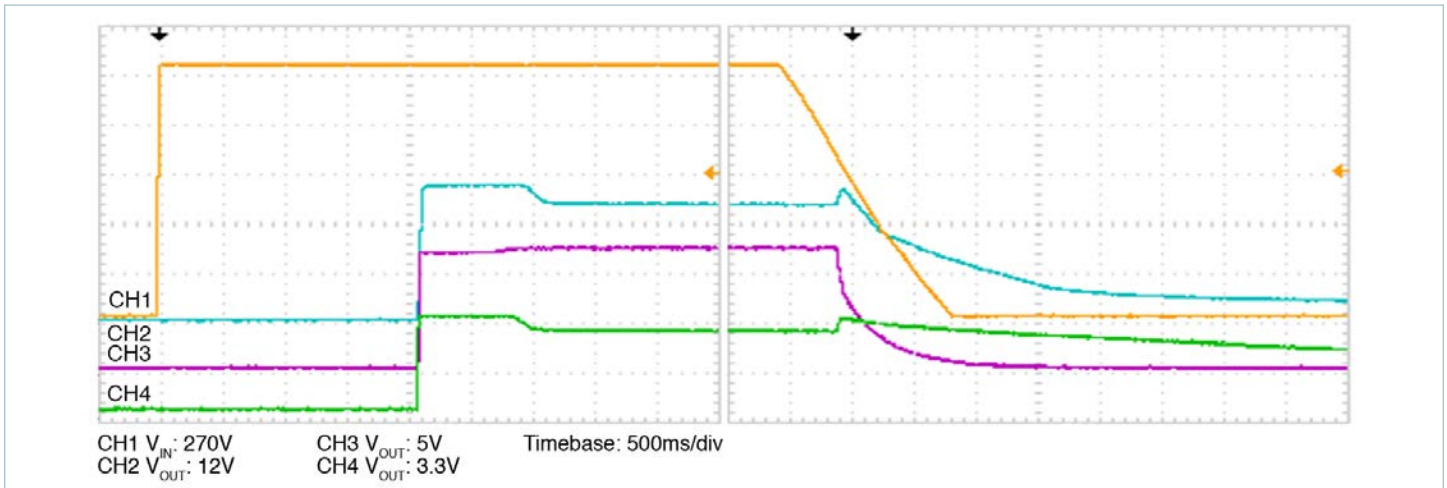

Figure 1 — Turn-on and turn-off characteristics at nominal line and nominal load, to main outputs

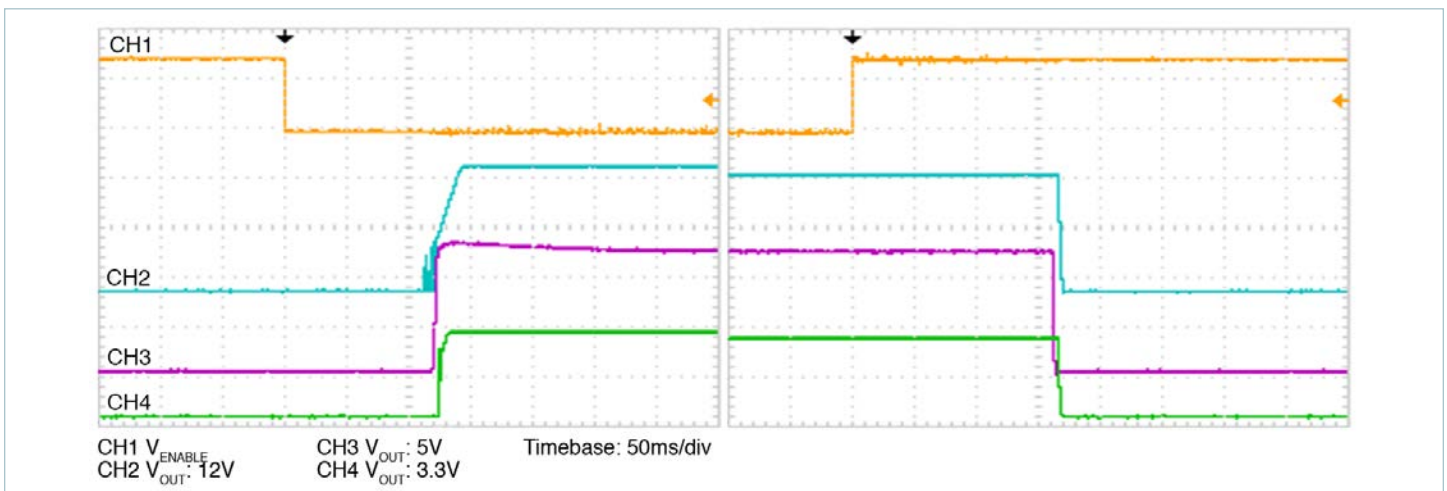

Figure 2 — Turn-on and turn-off time from enable to outputs

Application Characteristics (Cont.)

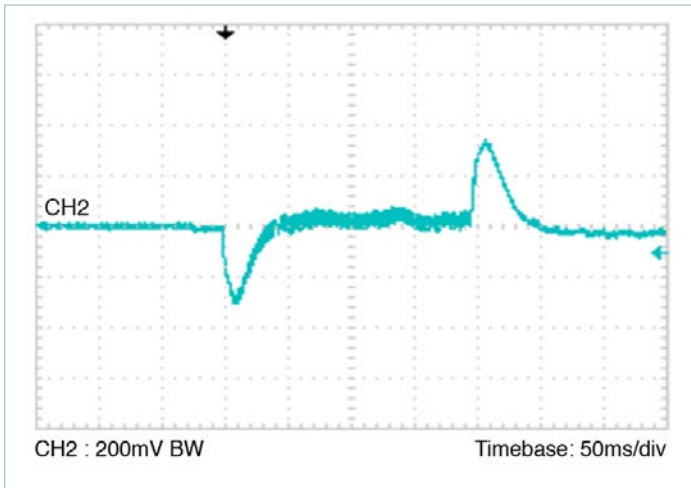

Figure 3 — Transient response, +12V output at nominal line,
10% – 90% – 10% load

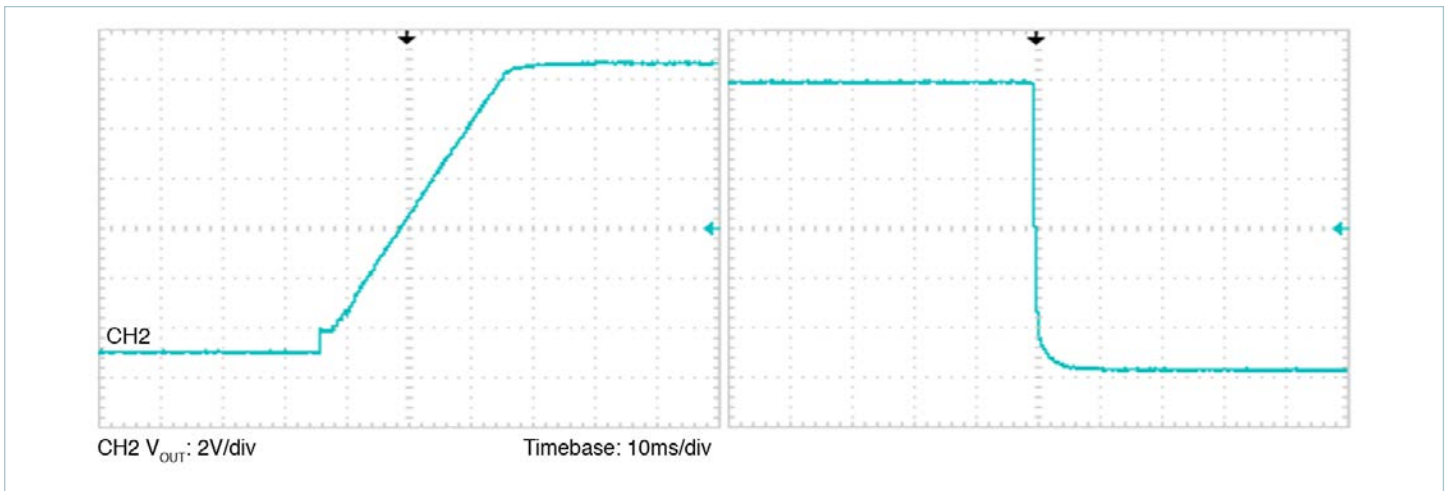

Figure 4 — Rise and fall, +12V output, nominal line, nominal load, enable/disable

Application Characteristics (Cont.)

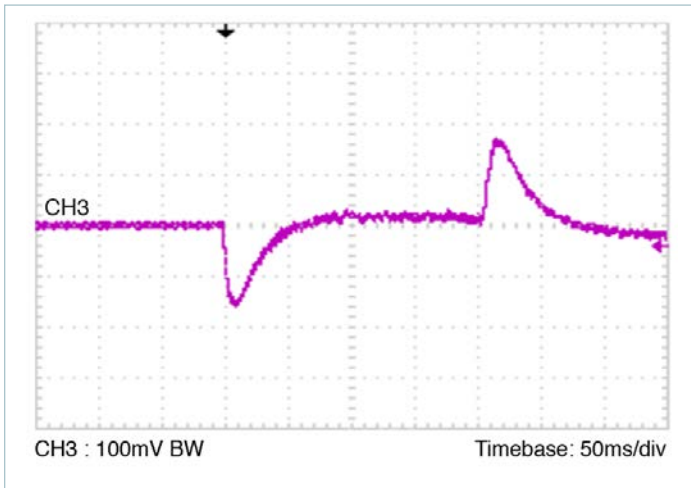

Figure 5 — Transient response, +5V output at nominal line, 10% – 90% – 10% load

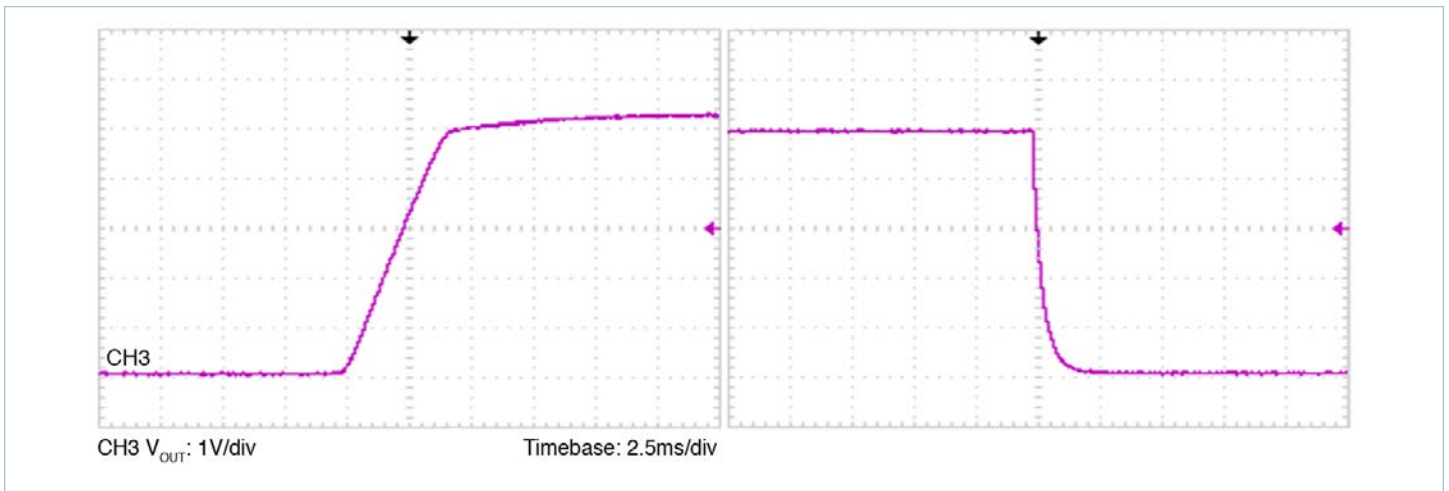

Figure 6 — Rise and fall, +5V output, nominal line, nominal load, enable/disable

Application Characteristics (Cont.)

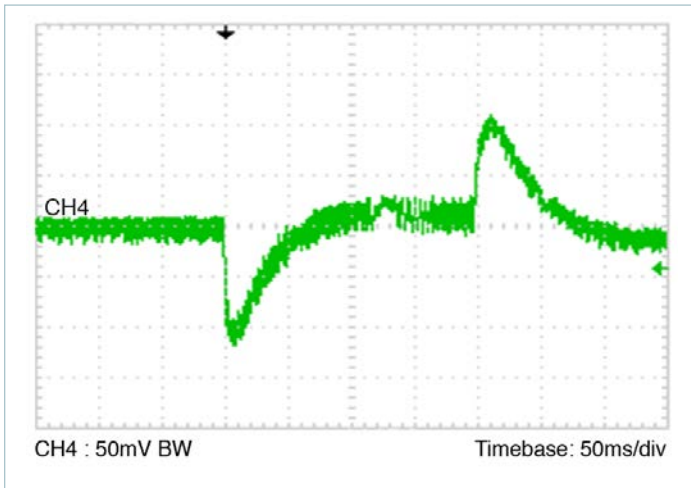

Figure 7 — Transient response, +3.3V output at nominal line, 10% – 90% – 10% load

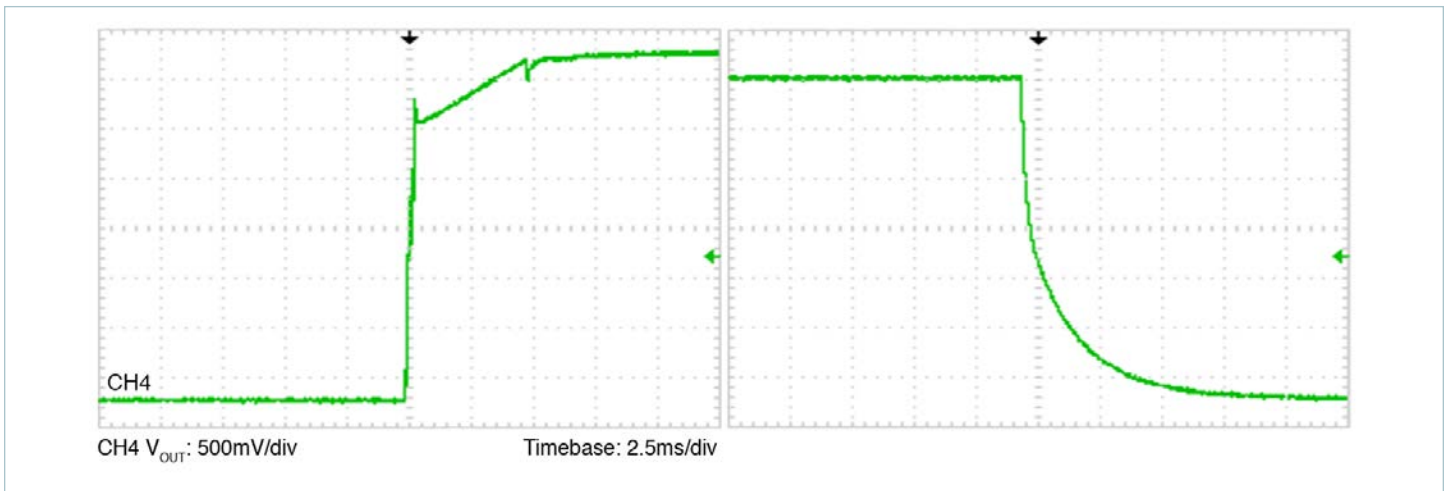

Figure 8 — Rise and fall, +3.3V output, nominal line, nominal load, enable/disable

General Characteristics

Attribute	Symbol	Conditions / Notes	Min	Typ	Max	Unit
Mechanical						
Length	L	Per VITA62		6.634		in
Width	W	Per VITA62		3.937		in
Height	H	Per VITA62		0.951		in
Weight	W			665 [23.5]		g [oz]
Wedge-Lock Torque		Manufacturer's recommended value		7		in-lbs
Thermal						
Operating Temperature	T _{WEDGE-LOCKS}		-40		85	°C
Assembly						
Storage Temperature			-40		125	°C
ESD Withstand	V _{ESD}	Human Body Model			2000	V
Safety						
MTBF		MIL-HDBK-217Plus Parts Count - 25°C Ground Benign, Stationary, Indoors / Computer		356,721		Hrs
		Telcordia Issue 2 - Method I Case III; 25°C Ground Benign, Controlled		709,585		Hrs

Signal Pin Functions

ENABLE* & INHIBIT*

Enable and Inhibit pins express active low logic. Table 1 has the truth table for the output state of the power supply. It is necessary to avoid the indeterminate output state where 0.8 – 2.0V is applied to the ENABLE* or INHIBIT* pins.

A digital debounce filter is present on the signals of both pins to prevent false transitions. The ENABLE* and INHIBIT* also have a minimum delay between successive output enable transitions to prevent repeated starts into high capacitance loads. See detailed specifications for delays time limits.

ENABLE* Pin	INHIBIT* Pin	Output State and Notes
< 0.8V, Logic 0	> 2.0V or NO, Logic 1	All outputs available
< 0.8V, Logic 0	< 0.8V, Logic 0	Only +3.3V _{AUX} output available
> 2.0V or NO, Logic 1	Any	All outputs disabled
0.8V > V _{ENABLE*} < 2.0V	0.8V > V _{INHIBIT*} < 2.0V	Indeterminate state and must be avoided

Table 1 — ENABLE & INHIBIT logic

Geographical Address: GA0* & GA1*

Geographical address pins also exhibit active low logic. Table 2 has the truth table for the output state of the power supply. It is necessary to avoid the indeterminate state where 0.8 – 2.0V is applied to either address pins. A digital debounce filter is present on the signals of both pins to incorrect address assignment.

The geographical address is static and set on power up. The power supply's address cannot not change until power has been cycled and the states of the address pins have been modified before power up.

Typical External Circuits for Signal Pins

(ENABLE*, INHIBIT*, GA0*, GA1*, SYSRESET*, FAIL* and I²C Channels)

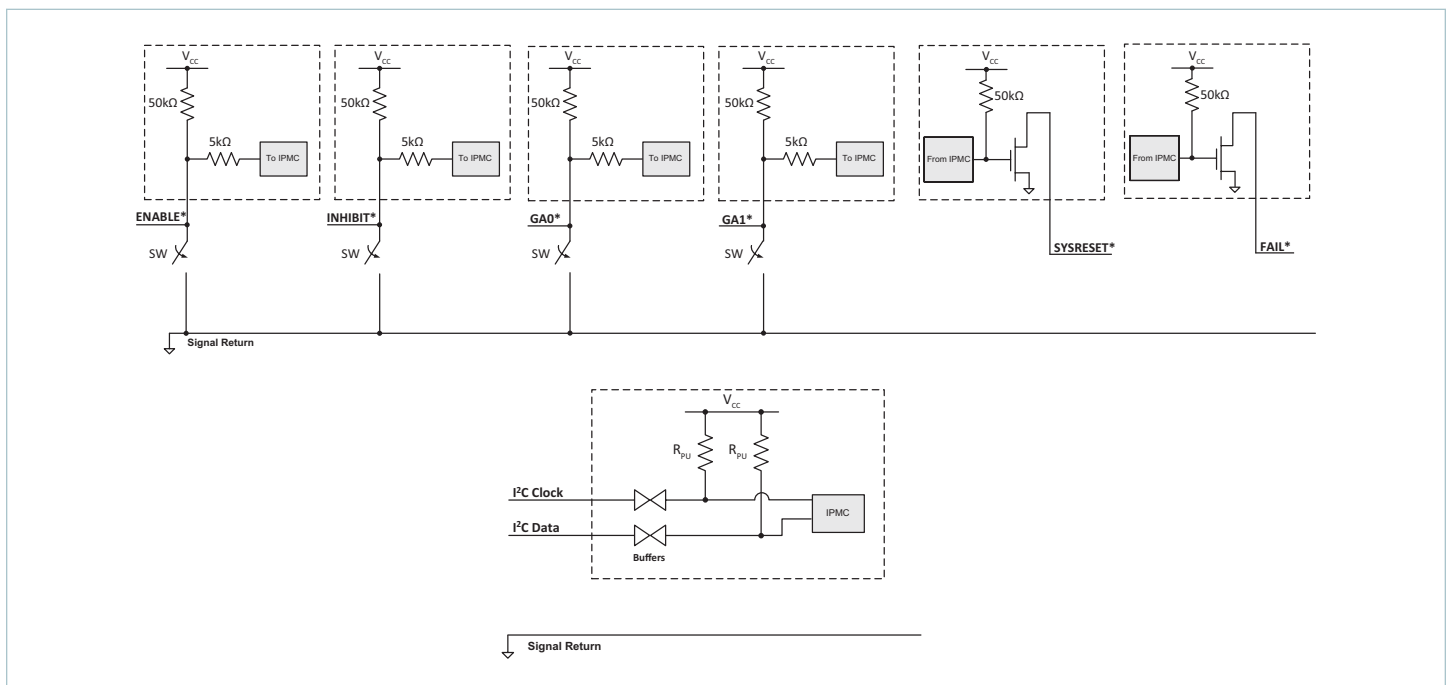

GA1*	GA0*	Power Supply Address
> 2.0V or NO, Logic 1	> 2.0V or NO, Logic 1	20h
> 2.0V or NO, Logic 1	< 0.8V, Logic 0	21h
< 0.8V, Logic 0	> 2.0V or NO, Logic 1	22h
< 0.8V, Logic 0	< 0.8V, Logic 0	23h
0.8V > V _{GA1*} < 2.0V	0.8V > V _{GA0*} < 2.0V	Indeterminate state and must be avoided

Table 2 — Geographical address assignment

I²C Ports:

Both primary and redundant I²C ports have the same address set by the Geographical Address pins and identical functionality. There is a bidirectional buffer on both clock and data lines with internal pull ups on the IPMC and external pulls on the back plane to +3.3V are required.

FAIL*

This signal line is open drain and tracks SYSRESET* when the unit is powering up or pulled down to SIGNAL_RETURN when any of the outputs are out of specification. A pull up resistor is expected on the backplane per section 4.6.3.7 of VITA 62.

SYSRESET*

This signal line is open drain and is pulled down to SIGNAL_RETURN when the unit is powering up. The line is released when the power supply is ready for control. Appropriate pull-up/pull-down resistors are expected on the back plane per VITA 46 section 7.3.9.

SIGNAL RETURN

SIGNAL RETURN is used as the reference for signals pin connections and is to be tied to POWER_RETURN on the backplane per section 4.6.3.10-1 of VITA 62.

Card Edge Temperature Sensors

The PCBA card edge temperature sensor internal to the power supply is mounted on the edge of the PCBA card edge. Consequently, the temperature sensor measures a temperature that is generally higher than the heat-sink-to-rail mounting interface and lower than the hot spot of the internal converters in the power supply.

Response from the power supply to I²C command 0x21 provides the temperature measured by the internal sensor that reads the higher temperature. This temperature can exceed 85°C. I²C command 0x92 will respond with both PCB mounted temperature sensors.

Fault Operation

See Table 5 for nonrecoverable fault thresholds which trigger a fault and shut down/restart of the outputs of the supply.

Input Voltage Protection (IOVP)

If the input voltage to the power supply drops below V_{UV-IN} or exceeds V_{OV-IN} for at least 1ms, the power supply will shut down all outputs and digital communication lines until input voltage is within operating range V_{IN} . Triggering I_{OVP} has the same effect as power cycling the power supply. Supply currents and voltages are sampled every 200 μ s.

Output Voltage Protection (OVP)

The power supply measures voltage from the remote-sense lines as well as the voltages on the VITA connector which do not include remote sense drop.

The FAIL* line will be asserted (pulled low) when output voltage at the connector of the power supply is greater than the nonrecoverable limit of any output. OVP will also shut down the outputs until the output voltage of the converter is within specification. The power supply will automatically restart the outputs every 1s until the fault clears.

Overcurrent Protection (OCP)*

During an overcurrent fault on any output, all outputs will shut off and the FAIL* line will be asserted. The power supply will automatically try to restart outputs every 1s if the fault has cleared.

Overtemperature Protection (OTP)

The power supply will go into overtemperature protection and shut down all outputs when either internal temperature sensor measures 95°C. The power converter will recover for normal operation when the internal temperature has dropped by 20°C.

At 85°C the Bit-5 of the Status Register (0x55) will clear if the system manager sets Bit-5 to 1 which will indicate the power supply is within 10°C from shutting down.

Parallel Operation

For proper load regulation and paralleling of like power supplies, a single kelvin connection between each sense pin and load is required. Under normal parallel power supply operation, each supply's PoL regulated output will be at different voltage with respect to its own backplane connector to compensate for transmission voltage drop. Figure 32a depicts an instance of a backplane with three power supplies where the point-of-load (PoL) sense pins on each power supply are connected.

It is not recommended to connect the PoL sense pins in a manner depicted in Figure 32b where each supply's PoL sense pins are connected to each other and also to each power supply's own PoL voltage output. In this case the system may appear to function normally temporarily but load regulation and sharing are not guaranteed due to the lack of a kelvin connection between the supplies and a single load point.

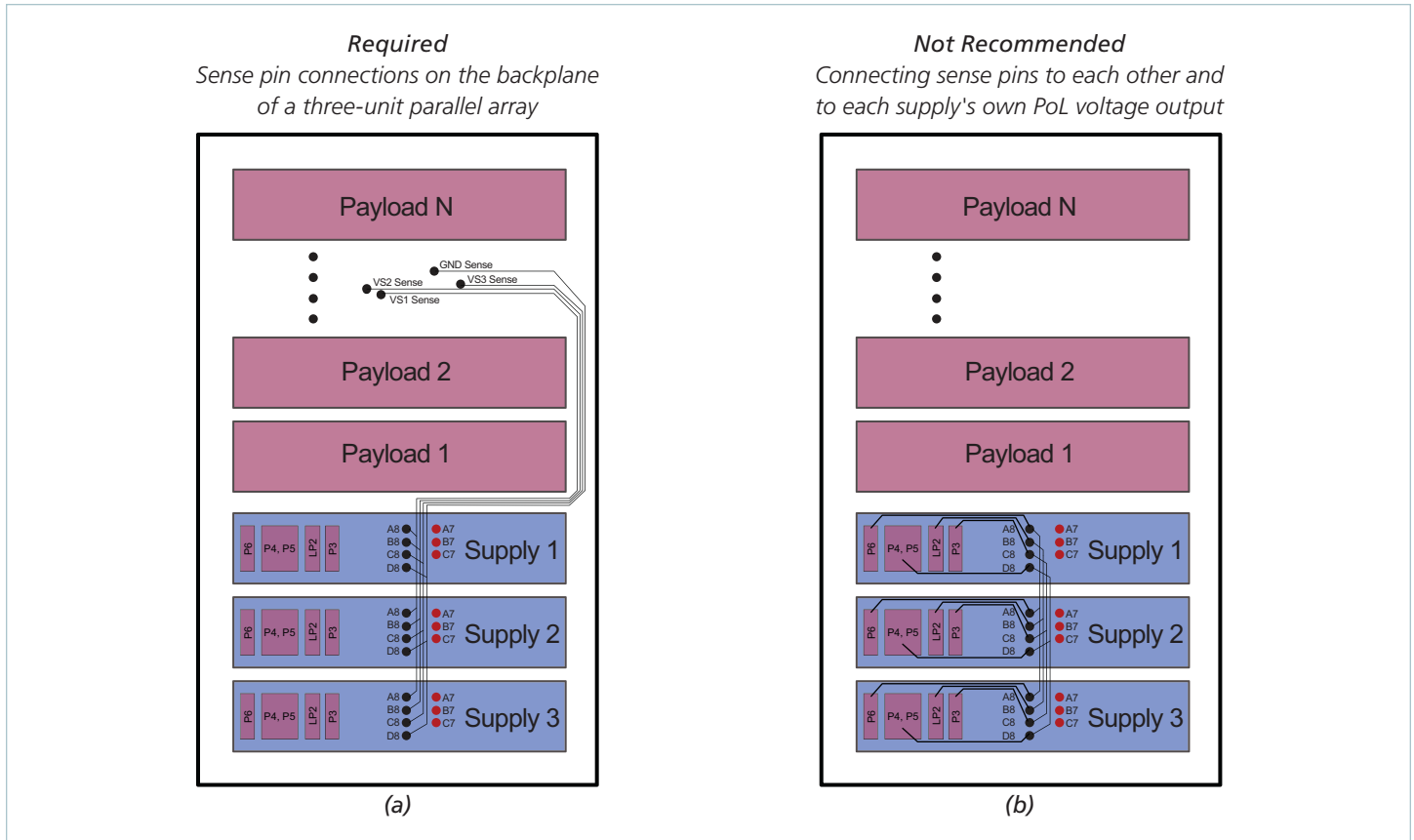

Figure 9 — Sense pin connection arrangement connects all supplies to the backplane of the array

All six outputs can be connected in parallel with the same output from other power supplies with the same part number. Only VS1, VS2 and VS3 support load sharing. The combined current output of paralleled AUX outputs is limited to the ampacity of respective individual AUX outputs of a single power supply.

Output	Max Current vs. Paralleled Supplies				Unit
	1	2	3	4	
VS1 (+12V)	40	72	108	144	A
VS2 (+3.3V)	20	36	54	72	A
VS3 (+5V)	30	54	81	108	A
VAUX1 (-12V)	1	1	1	1	A
VAUX2 (+3.3V)	6	6	6	6	A
VAUX3 (+12V)	1	1	1	1	A

Table 3 — Maximum current rating by output for parallel arrays

Standalone Operation

Switching the power supply from paralleling to standalone can be done on a single-use basis or permanently by the user using I²C.

Each unit ships from the factory capable of paralleling multiple identical power supplies. If the power supply is used in standalone mode without additional identical supplies connected in parallel, the output voltages of the power supply that are shareable, namely, VS1, VS2 and VS3, will not droop with increased current load and will regulate the output voltage close to the no-load voltage. The standalone mode of operation may be desirable in applications where output voltage tolerance requirements exceed the limits allowed by VITA 62 and only one power supply is required.

In order to set the power supply to standalone mode the byte sequence shown in Table 4 needs to be transmitted to the power supply.

IPMB Byte Number	Hex Byte	Comment
0	40h	Initiation of Communication; transmit request to the power supply. Address byte of power supply with hardware address 0x20 and LSB read/write low.
1	66h	Command byte 1
2	99h	Command byte 2
3	10h	Command byte 3
5	F1h	Zero checksum of IPMB bytes 1-3 and Stop Bit

Table 4 — Byte sequence to set the power supply in standalone

To verify if the power supply is in standalone mode, VS1 remote-load sense voltage can be measured between connector pin A8 and sense return D8. The voltage between A8 and D8 will drop less than 40mV between no-load and full-load. If the power supply is in paralleling mode, VS1 remote-load sense voltage measured between connector pin A8 and sense return D8 will vary over 100mV between no-load and full-load.

To set the power supply to share mode again, command byte 3 in Table 4 needs to change to 00h. The checksum for bytes 1 – 3 will need to be recalculated and transmitted to the power supply. The sequence will need to be transmitted to the power supply a total of 3 times for the power supply to permanently change its mode at power up to support current share or paralleling.

To permanently change the power supply to either standalone or paralleling mode, the sequence in Table 4 with byte 3 set correctly needs to be transmitted three times consecutively. Committing the change permanently will cause the power supply to adopt the desired mode of operation from power up. If the power supply mode of operation is changed permanently, the power supply will perform a soft reboot once to store settings in its internal memory. The power supply can be switched from paralleling to standalone and vice-versa permanently up to 100,000 times due to memory wear limitations. Switching mode of operation without committing changes permanently can be done as many times as the user requires. If the mode of operation is switched without committing the change permanently, the power supply will revert to the mode of operation set permanently after a power cycle.

Conducted Emissions Testing

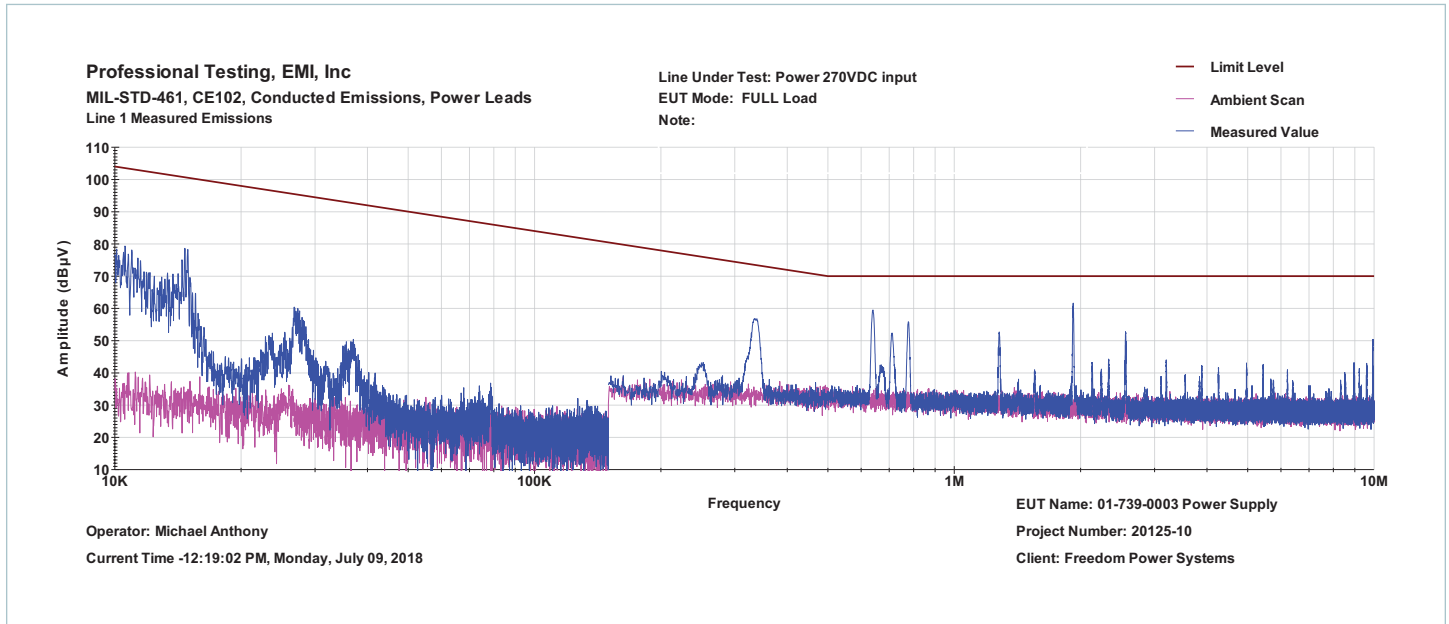

Figure 10 — Conducted emissions of 270V_{DC} input at full load

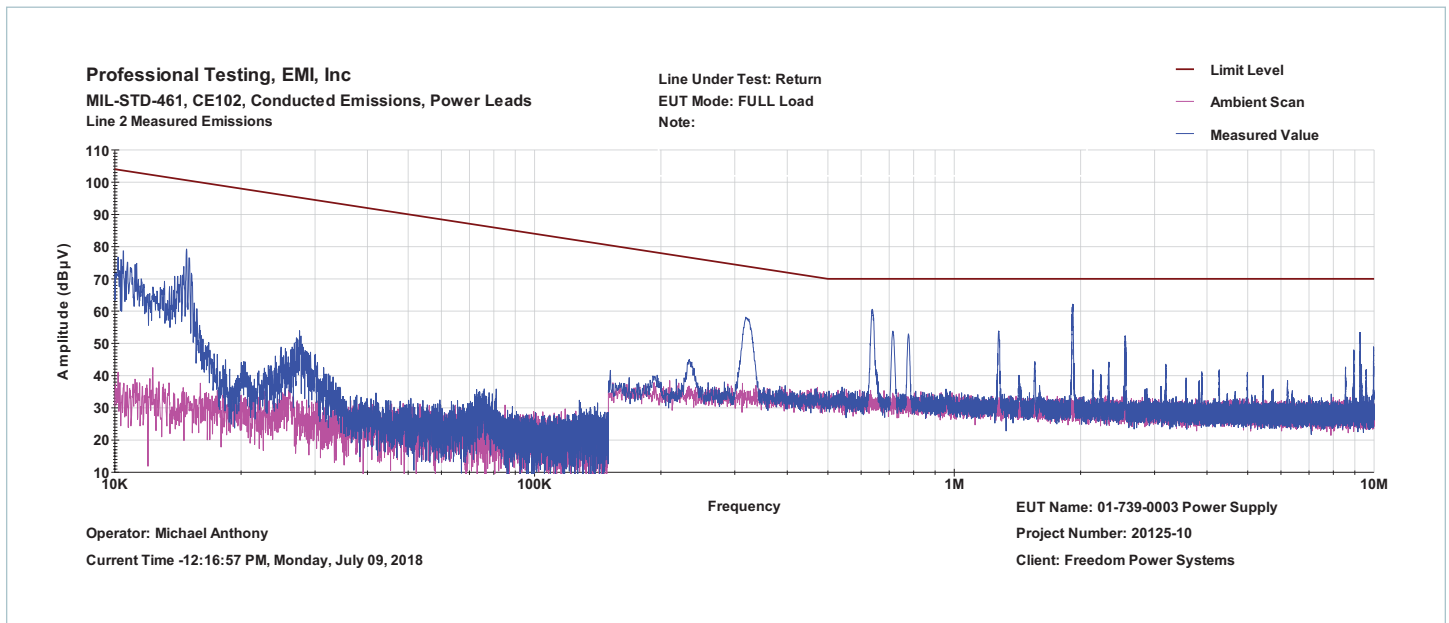

Figure 11 — Conducted emissions of power return at full load

Conducted Emissions Testing (Cont.)

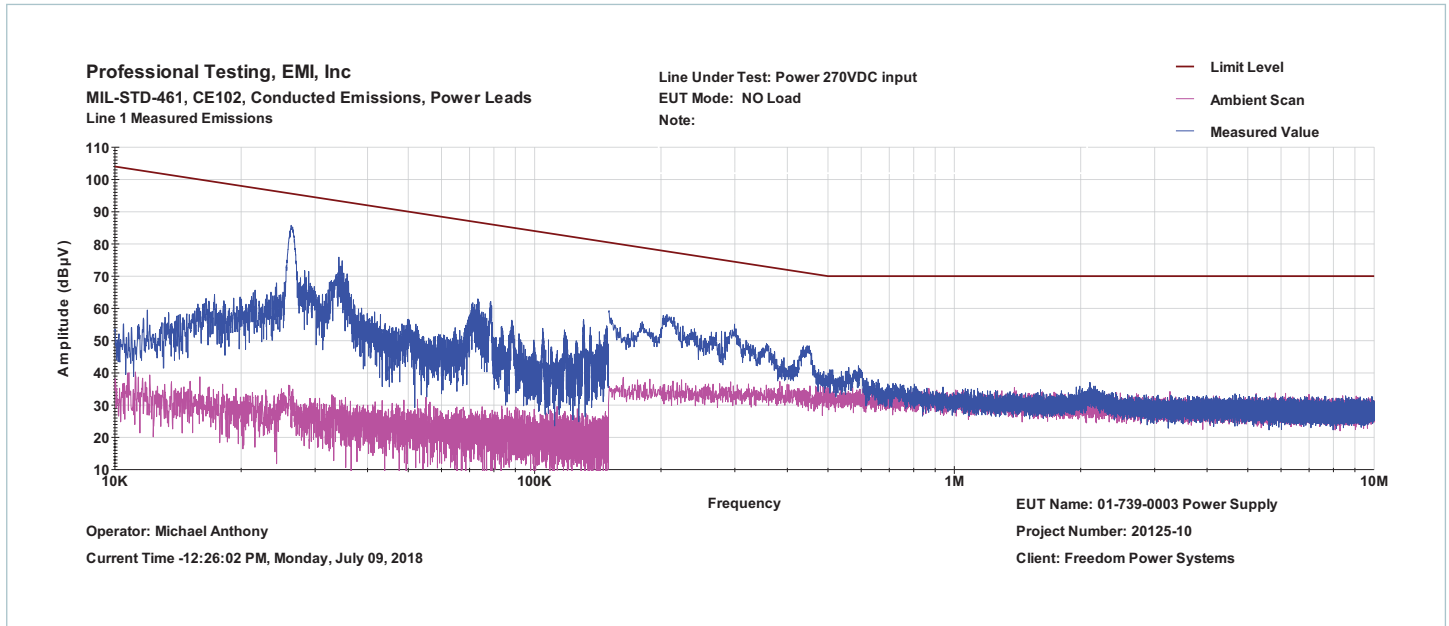

Figure 12 — Conducted emissions of 270V_{DC} input at no load

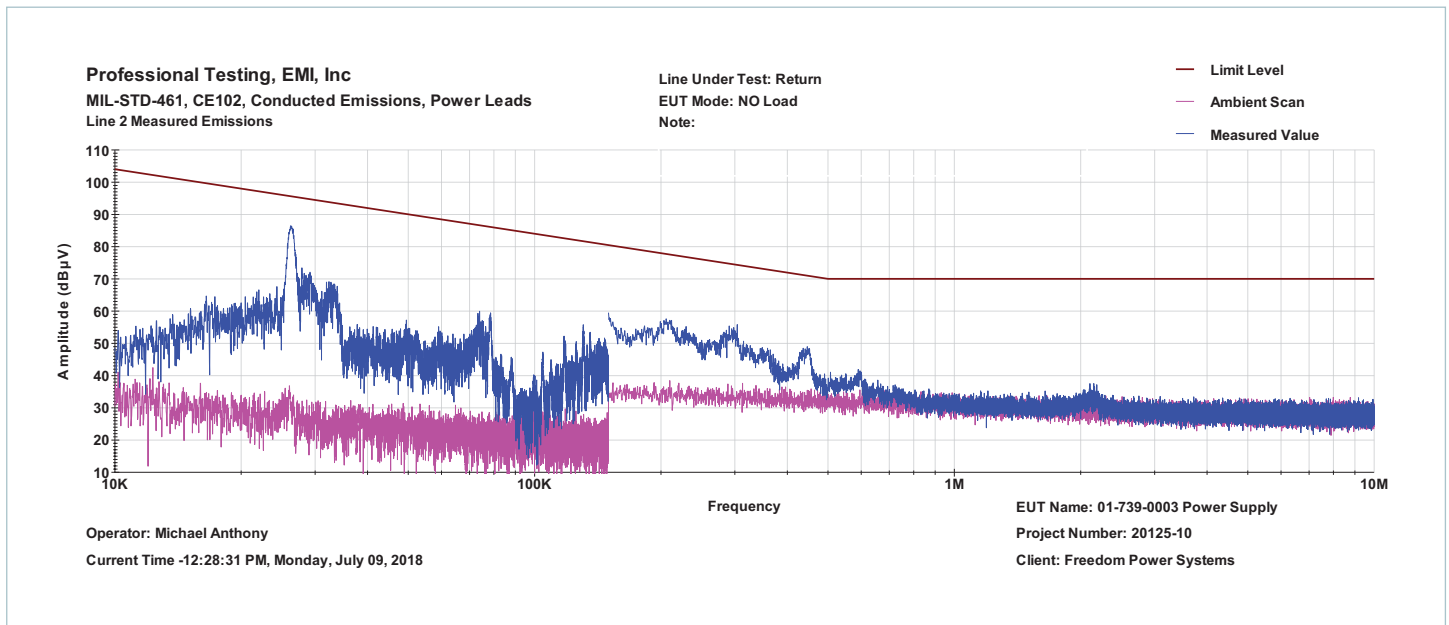

Figure 13 — Conducted emissions of power return at no load

Standards Compliance

MIL-STD-461F		
CE102 Power Lead	10kHz – 10MHz FIGURE CE102-1, 270V Curve See Figures 9 – 12	Pass
CS101 Power Lead	30Hz – 150kHz Curve 1	Pass
CS114, Bulk Cable (Power)	10kHz – 200MHz Curve 5	Pass
CS114, Bulk Cables (I/O)	10kHz – 200MHz Curve 5	Pass
CS115 Bulk Cable (Power)	Impulse Excitation FIGURE CS115-1	Pass
CS115 Bulk Cables (I/O)	Impulse Excitation FIGURE CS115-1	Pass
CS116 Bulk Cable (Power)	Damped Sinusoidal Transients 10kHz – 100MHz FIGURE CS116-2	Pass
CS116 Bulk Cables (I/O)	Damped Sinusoidal Transients 10kHz – 100MHz FIGURE CS116-2	Pass
MIL-STD-704F-7		
Normal Transients HDC-105		Pass
Abnormal Transients HDC-302		Pass
Distortion Spectrum HDC-103		Pass
MIL-STD-810G		
Vibration Method 514.6 Procedure I	5 – 100Hz PSD increasing at 3dB/octave	Pass
	100 – 1000Hz PSD = 0.1g ² /Hz	
	1000 – 2000Hz PSD decreasing at 6dB/octave	
Operating Shock, Method 516 Procedure I	40g, 11ms shock half-sine	Pass
	40g, 11ms, terminal saw tooth shock pulses in all three axes	

I²C Sensor Commands

Commands are sent by SMBus-compatible packets over the I²C physical interface. The I²C bus will communicate at 100kHz. Pull-up resistors to +3.3V are expected on the system backplane.

Two pins, labeled *GA1 and *GA0 are provided at each power supply slot, where *GA1 and *GA0 are defined to be active (SET) when low. The power supply will respond to I²C address 010 00[GA1][GA0].

The power supply supports commands to read sensor data from the power supply without utilizing VITA 46.11 or IPMI. The commands are similar to register reads in from I²C memory and function in a parent/child configuration. Unlike VITA 46.11 which is a multi-parent protocol, commands defined in this section are parent-write and parent-read.

Table 5 shows the following transmission pattern for reading power supply rail temperatures with command 0x92 using the parent-write/parent-read transmission format. In all non-VITA 46.11 commands, the parent requests the data from the child, which is the power supply.

IPMB Byte Number	Hex Byte	Clock Pulses Generated By	Data Pulses Generated By	Comment	Real Value
1	40h	Requestor	Requestor	Initiation of Communication; transmit request to the power supply; Address byte of power supply with hardware address 0x20 and LSB read/write low	
2	92h	Requestor	Requestor	Command to read power supply temperatures	
3	6Eh	Requestor	Requestor	Zero checksum generated from IPMB byte 2 (or all bytes after Address Byte up to the checksum byte)	
4	41h	Requestor	Requestor	Read response from the power supply; Address byte of power supply with hardware address 0x20 and LSB read/write high	
5	92h	Requestor	Power Supply	Response byte 1 Echo of the command from the requestor	
6	01h	Requestor	Power Supply	Response byte 2	013Bh = 31.5°C
7	3Bh	Requestor	Power Supply	Response byte 3	
8	01h	Requestor	Power Supply	Response byte 4	0146h = 32.6°C
9	46h	Requestor	Power Supply	Response byte 5	
10	EBh	Requestor	Power Supply	Zero checksum of IPMB bytes 6-9	

Table 5 — Communication example of command non-VITA 46.11 command 0x92

Checksum bytes are 2's complement checksum of bytes in the request excluding the address byte or between the previous checksum and next checksum excluding the address byte.

8-bit checksum algorithm:

1. Initialize checksum to 0.
2. For each applicable byte, checksum = (checksum + byte) modulo 256.
3. Then checksum = - checksum.

Verification

When the checksum and the bytes are added together, modulo 256, the result should be 0.

Example of the checksum for the data returned by the power supply in Table 5.

$$\Leftrightarrow 256 - \left(\sum_{x=5}^9 IPMB_Bytes\ x \right) \bmod 256 = EBh$$

$$\Leftrightarrow 256 - \left((92h + 01h + 3Bh + 01h + 46h) \bmod 256 \right) = EBh$$

Verification:

$$\left(EBh + (92h + 01h + 3Bh + 01h + 46h) \right) \bmod 256 = 0$$

Table 6 shows how to set and read the Status Register Byte.

Checksum bytes are 2's complement checksum of bytes in the request excluding the address byte or between the previous checksum and next checksum excluding the address byte.

IPMB Byte Number	Hex Byte	Clock Pulses Generated By	Data Pulses Generated By	Comment
Status Register READ				
0	40h	Requestor	Requestor	IPMB address write
1	55h	Requestor	Requestor	Command
2	ABh	Requestor	Requestor	Zero checksum
3	41h	Requestor	Requestor	Read response
4	55h	Requestor	Power Supply	Echo command
5	02h	Requestor	Power Supply	Status register: hardware control, all outputs enabled
6	A9h	Requestor	Power Supply	Zero checksum
Status Register WRITE				
0	40h	Requestor	Requestor	IPMB address write
1	55h	Requestor	Requestor	Command
2	18h	Requestor	Requestor	Software control, all outputs enabled
3	93h	Requestor	Requestor	Zero checksum
4	41h	Requestor	Requestor	Read response
5	55h	Requestor	Power Supply	Echo command
6	1Ah	Requestor	Power Supply	Status register: software control, all outputs enabled
7	91h	Requestor	Power Supply	Zero checksum

Table 6 — Communication example of status register byte

Commands Recognized by Power Supply

0x21: Sensor Data (Read Only) ^[d]			
Byte Number	Contents	Format	Scaling
0	0x21	Byte	Echo of the command
1	Status Reg	Byte	See below, same as used by command 0x55
2, 3	PCBA Temperature °C	UINT16	16384 = 100°C
4, 5	+12V VSENSE	UINT16	16384 = 12.0V
6, 7	+3.3V VSENSE	UINT16	16384 = 3.3V
8, 9	+5V VSENSE	UINT16	16384 = 5.0V
10, 11	+3.3VAUX VSENSE	UINT16	16384 = 3.3V
12, 13	+12VAUX VSENSE	UINT16	16384 = 12.0V
14, 15	-12VAUX VSENSE	UINT16	16384 = -12.0V, absolute value
16, 17	+12V IOUT	UINT16	16384 = 40A
18, 19	+3.3V IOUT	UINT16	16384 = 20A
20, 21	+5V IOUT	UINT16	16384 = 30A
22, 23	+3.3VAUX IOUT	UINT16	16384 = 6A
24, 25	+12VAUX IOUT	UINT16	16384 = 1A
26, 27	-12VAUX IOUT	UINT16	16384 = -1A, absolute value
28, 29	INT REFERENCE	UINT16	16384 = 2.50V
30, 31	Factory Use Only	UINT16	N/A: factory use only
32 – 51	Part Number	CHAR[20]	no 0 term, padded with 0x20
52 – 55	Serial Number	UINT32	Unsigned 32-bit integer; last 9 digits of the serial number of the unit on the label
56, 57	Factory Use Only	UINT16	N/A: factory use only
58, 59	Hardware Rev	CHAR[2]	
60, 61	Firmware Rev	CHAR[2]	
62	Input Current	UINT8	255 = 60A
63	Zero Checksum	Byte	Sum(Bytes 0:63) mod 256 = 0

^[d] Most-significant bit of each byte is transmitted first.
Most-significant byte of UINT16 and UINT32 transmitted first.

Non-VITA 46.11 Recognized by Power Supply

0x44: Firmware Date (Read Only) ^[e]			
• 22 byte response in ASCII form.			
Byte Number	Contents	Format	Typical Value/Comment
0	0x44	Byte	Echo of the command
1 – 20	Date	ASCII[20]	'NOV 28 14:32:54 2018'
21	Zero Checksum	Byte	Sum(Bytes 0:21) mod 256 = 0
0x45: Hardware Address (Read Only) ^[e]			
Byte Number	Contents	Format	Typical Value/Comment
0	0x45	Byte	
1	I ² C Address	Byte	0x23, set by *GA1, *GA0
2	Zero Checksum	Byte	Sum(Bytes 0:2) mod 256 = 0
0x55: Status Command (Read/Write) ^[e]			
Byte Number	Contents	Format	Typical Value/Comment
0	0x55	Byte	
1	Status Byte	Byte	0x18 = All outputs ON
2	Zero Checksum	Byte	Sum(Bytes 0:2) mod 256 = 0
0x90: All Voltages in mV (Read Only) ^[e]			
Byte Number	Contents	Format	Scaling/Comment
0	0x90	Byte	Echo of the command
1, 2	+12V SENSE	UINT16	10mV/bit
3, 4	+3.3V SENSE	UINT16	10mV/bit
5, 6	+5V SENSE	UINT16	10mV/bit
7, 8	+3.3VAUX SENSE	UINT16	10mV/bit
9, 10	+12VAUX VSENSE	UINT16	10mV/bit
11, 12	-12VAUX VSENSE	UINT16	-10mV/bit
13, 14	Input Voltage	UINT16	10mV/bit
15	Zero Checksum	Byte	Sum(Bytes 0:15) mod 256 = 0

^[e] Most-significant bit of each byte is transmitted first.
Most-significant byte of UINT16 and UINT32 transmitted first.

Non-VITA 46.11 Recognized by Power Supply (Cont.)

0x99: Main Outputs – Output and Input Current in mA (Read Only) ^[e]

Byte Number	Contents	Format	Scaling/Comment
0	0x99	Byte	Echo of the command
1, 2	+12V IOUT	UINT16	10mA/bit
3, 4	+3.3V IOUT	UINT16	10mA/bit
5, 6	+5V IOUT	UINT16	10mA/bit
7, 8	Input Current	UINT16	10mA/bit
9	Zero Checksum	Byte	Sum(Bytes 0:9) mod 256 = 0

0x91: Auxiliary Outputs – Output Current in mA (Read Only) ^[e]

Byte Number	Contents	Format	Scaling/Comment
0	0x91	Byte	Echo of the command
1, 2	+3.3VAUX IOUT	UINT16	1mA/bit
3, 4	+12VAUX IOUT	UINT16	1mA/bit
5, 6	-12VAUX IOUT	UINT16	-1mA/bit
7	Zero Checksum	Byte	Sum(Bytes 0:7) mod 256 = 0

0x92: PCBA Card Edge Temperatures in °C x 10 (Read Only) ^[e]

Byte Number	Contents	Format	Scaling/Comment
0	0x92	Byte	Echo of the command
1, 2	3U P0 connector, P1 side Rail	INT16	Temperature x 10, eg. -123 = -12.3°C
3, 4	3U P0 connector, P6 side Rail	INT16	Same as above
5	Zero Checksum	Byte	Sum(Bytes 0:5) mod 256 = 0

Status Register Bit Map used in command 0x55

Bit 0 and 1 allow you to monitor what the power supply is reading from the input connector.

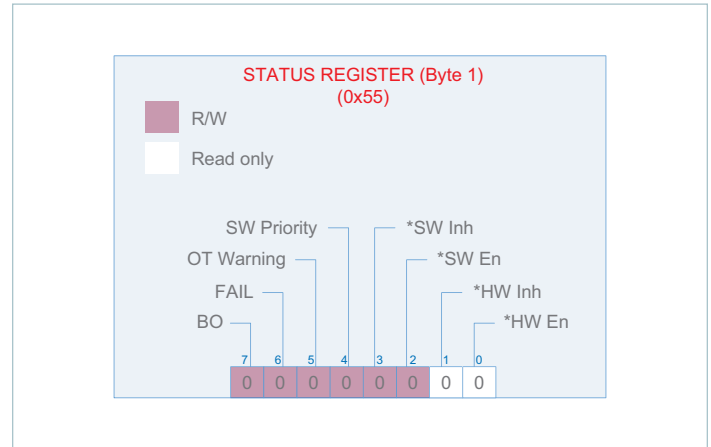

Under some conditions, it is desirable to ignore potentially damaging conditions. For this purpose the power supply provides a battle override function in the system status register. If bit 7 in the status register is set, then any non-recoverable events that would normally shut down the supply will not do so.

Event messages are still sent, but the power supply will continue to operate until the conditions cease to exist or it fails.

In order to enable battle override mode, the command message must include the exact same data byte three times in a row within the message where normally only a single byte would be needed.

Bit	Name	Condition	Default
7	BO	Battle override; see description	0
6	FAIL	If set to 1 by System Manager, a fault condition will clear this bit.	0
5	OT Warning	If set to 1 by System Manager, an OT fault will clear this bit.	0
4	SW Priority	Software Priority 1 = STATUS REGISTER overrides hardware inputs for INHIBIT* and ENABLE* 0 = Hardware is in control	0
3	*SW Inh	Software Inhibit 0 = Inhibit active (same as hardware input state)	0
2	*SW En	Software Enable 0 = Enable active (same as hardware input state)	0
1	*HW Inh	Status of INHIBIT* pin (read only)	From backplane
0	*HW En	Status of ENABLE* pin (read only)	From backplane

IPMI Interface

The data interface is compliant with the requirements of VITA 46.11, VITA 62 -2016 and the IPMI v2.0 specifications. This section shows product specific information such as a sensor list and their coefficients.

Data Format

Four constants are used to calculate a real world value from the single byte variable returned in the response. The four constants are used in the equation Interpreting Received Values

$$y = (Mx + (B \cdot 10^{K1})) \cdot 10^{K2}$$

Where:

- y** the converted reading
- x** the raw sensor reading
- M** the signed integer multiplier
- B** the signed additive offset
- K1** signed exponent for constant B (sets decimal point for B)
- K2** signed result exponent (sets decimal point for y)

Sensors and Constants

The list of sensors and coefficients can also be retrieved by the chassis manager by querying the "Sensor Data Record" (See VITA 46.11).

Sensor			Units	Simplified Conversion Equation ^[f]	Sensor Type Code	Conversion Coefficients			
#	Hex	Name				M	B	K1	K2
7	0x07	Input Voltage	V	Reserved Not supported at this time	02h Voltage	N/A	N/A	N/A	N/A
8	0x08	+12V Voltage	V	Actual = Reading • 0.054		54	0	0	-3
9	0x09	+3.3V Voltage	V	Actual = Reading • 0.018		18	0	0	-3
10	0x0A	+5V Voltage	V	Actual = Reading • 0.046		46	0	0	-3
11	0x0B	+3.3V _{AUX} Voltage	V	Actual = Reading • 0.018		18	0	0	-3
12	0x0C	+12V _{AUX} Voltage	V	Actual = Reading • 0.054		54	0	0	-3
13	0x0D	-12V _{AUX} Voltage	V	Actual = Reading • -0.054		-54	0	0	-3
14	0x0E	Input Current	A	Reserved Not supported at this time	03h Current	N/A	N/A	N/A	N/A
15	0x0F	+12V Current	A	Actual = Reading • 0.20		20	0	0	-2
16	0x10	+3.3V Current	A	Actual = Reading • 0.20		20	0	0	-2
17	0x11	+5V Current	A	Actual = Reading • 0.20	20	0	0	-2	
18	0x12	Card Edge P6 Left	K	Actual = 200 + Reading	01h Temperature	1	20	1	0
19	0x13	Card Edge P1 Right	K	Actual = 200 + Reading		1	20	1	0
20	0x14	Mid-chassis Temp	K	Reserved Not supported at this time	0Bh Other Units-based Sensor	N/A	N/A	N/A	N/A
21	0x15	Input Power	W	Reserved Not supported at this time		N/A	N/A	N/A	N/A
22	0x16	+12V Power	W	Actual = Reading • 2.5		25	0	0	-1
23	0x17	+3.3V Power	W	Actual = Reading • 0.4		4	0	0	-1
24	0x18	+5V Power	W	Actual = Reading		10	0	0	-1
25	0x19	+3.3V _{AUX} Current	A	Actual = Reading • 0.05		50	0	0	-3
26	0x1A	+12V _{AUX} Current	A	Actual = Reading • 0.02		20	0	0	-3
27	0x1B	-12V _{AUX} Current	A	Actual = Reading • 0.02	20	0	0	-3	
28	0x1C	AUX Power	W	Actual = Reading • 0.8	0Bh Other Units-based Sensor	8	0	0	-1
33	0x22	Output Power	W	Actual = Reading • 3		30	0	0	-1

Table 7 — Analog sensors reading conversion factors

^[f] Reading is a one-byte value (0 – 255).

Thresholds

Upper and lower limits of the sensors are shown in Table 5. Exceeding the nonrecoverable or critical limits will trigger a system event message and set the appropriate bits in the warning sensor registers (Sensors 2, 3 and 4). They reflect a degradation of the power supply towards its operational limits but are still within operating norms.

Exceeding nonrecoverable limits of the power supply will cause the power supply to shut down all outputs except the 3.3V internal supply which powers the microcontroller and bus interface. The system will try to recover from all nonrecoverable faults after 1s shut down of all outputs.

The high non-recoverable threshold of the input voltage is set to 255h (60V) since the unit is capable of operating through MIL-STD-1275E surges. The surge protection circuit inside the power supply will limit the input voltage to be inside the units allowable range during a surge. If a surge exceeding the maximum allowable limits persists, the unit will shut down for at least 25s and attempt auto-recovery.

Sensor			Conversion Coefficient				Low Critical Threshold		High Critical Threshold		Low NR Threshold		High NR Threshold		Hysteresis	
#	Name	Unit	M	B	K1	K2	x	Y	x	Y	x	Y	x	Y	x	Y
7	Input Voltage	V	Reserved Not supported at this time													
8	+12V Voltage	V	54	0	0	-3	213	11.5	231	12.474	209	11.286	236	12.744	3	0.162
9	+3.3V Voltage	V	18	0	0	-3	180	3.24	191	3.438	176	3.168	193	3.474	3	0.054
10	+5V Voltage	V	46	0	0	-3	105	4.83	112	5.15	102	4.692	113	5.198	3	0.138
11	+3.3V _{AUX} Voltage	V	18	0	0	-3	180	3.24	191	3.438	175	3.15	192	3.456	3	0.054
12	+12V _{AUX} Voltage	V	54	0	0	-3	212	11.44	231	12.474	208	11.232	235	12.69	3	0.162
13	-12V _{AUX} Voltage	V	-54	0	0	-3	227	-12.26	210	-11.34	208	-11.23	232	-12.53	3	-0.162
14	Input Current	A	Reserved Not supported at this time													
15	+12V Current	A	20	0	0	-2	0	0	180	36	0	0	230	46	20	4
16	+3.3V Current	A	20	0	0	-2	0	0	80	16	0	0	120	24	10	2
17	+5V Current	A	20	0	0	-2	0	0	13	26	0	0	175	35	10	2
18	Card Edge P6	K	1	20	1	0	38	238	158	358	32	232	168	368	10	10
19	Card Edge P1	K	1	20	1	0	38	238	158	358	32	232	168	368	10	10
20	Mid-chassis Temperature	K	Reserved Not supported at this time													
21	Input Power	W	Reserved Not supported at this time													
22	+12V Power	W	25	0	0	-1	0	0	192	480	0	0	220	550	6	15
23	+3.3V Power	W	4	0	0	-1	0	0	165	66	0	0	195	78	6	2.4
24	+5V Power	W	10	0	0	-1	0	0	130	130	0	0	172	172	6	6
25	+3.3V _{AUX} Current	A	50	0	0	-3	0	0.0	130	6.5	0	0.0	165	8.25	5	0.25
26	+12V _{AUX} Current	A	20	0	0	-3	0	0.0	45	0.9	0	0.0	70	1.4	5	0.1
27	-12V _{AUX} Current	A	20	0	0	-3	0	0.0	45	0.9	0	0.0	70	1.4	5	0.1
28	AUX Power	W	8	0	0	-1	0	0	123	98.4	0	0	140	112	5	4
33	OutputPower	W	30	0	0	-1	0	0	192	576	0	0	215	645	4	12

Table 8 — Analog sensors Critical and NR thresholds

Mechanical Drawing

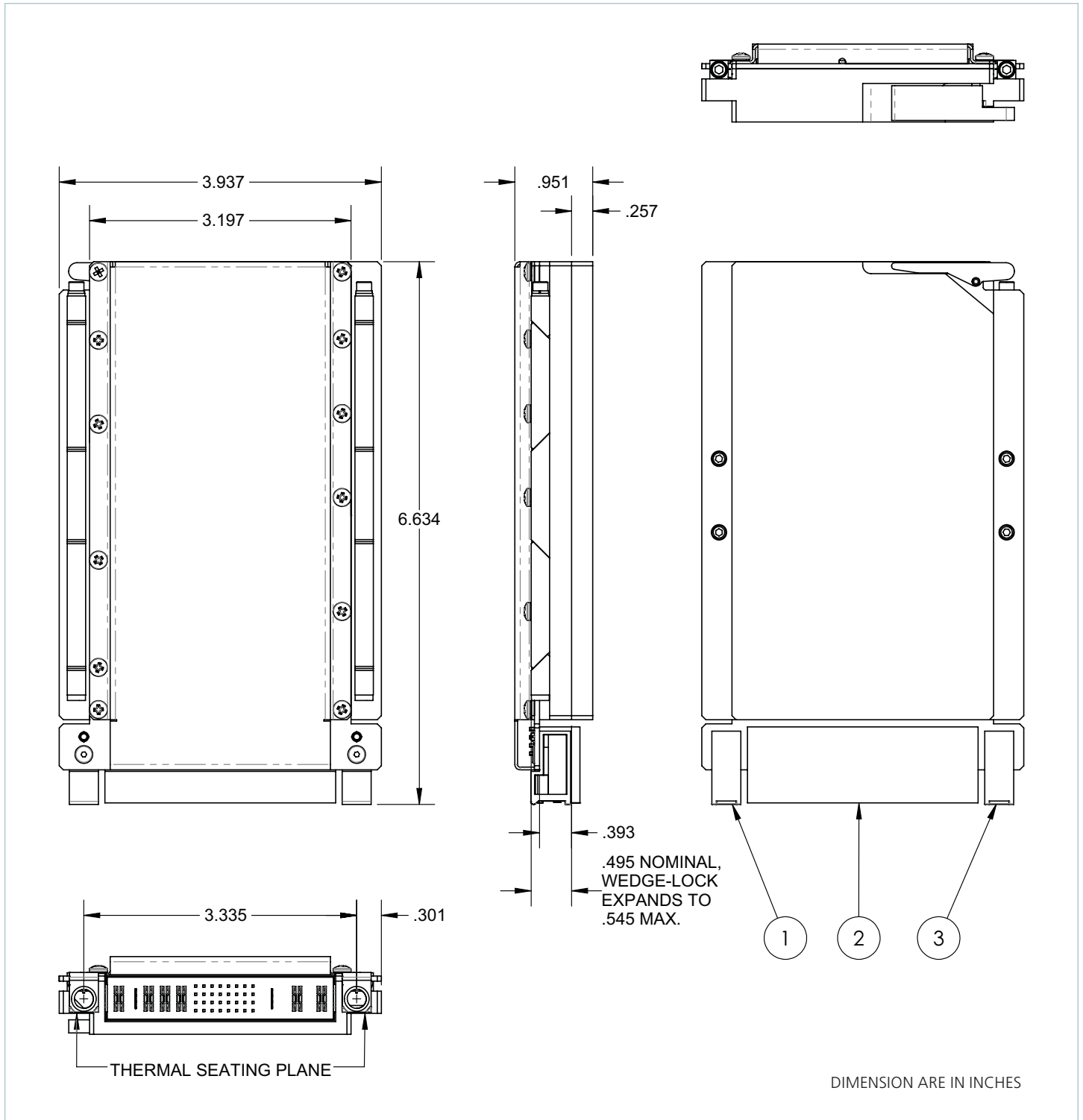

Connector Components

Item #	Description	Manufacturer	Manufacturer Part Number
1	VITA46 0 DEG Guide Socket	TE Connectivity	1-1469492-1
2	VITA62 Connector Plug	TE Connectivity	6450849-7
3	VITA46 315 DEG Guide Socket	TE Connectivity	1-1469492-8

Revision History

Revision	Date	Description	Page Number(s)
1.0	08/21/18	Initial release	n/a
1.1	10/15/18	Updated features & benefits, product description Updated connector pin descriptions Updated current specs for main +3.3V output Updated 0x21 table Updated command 0x55 table	1 3 6 15 16
1.2	05/30/19	Updated output ripple/noise specs for -12V and +12V outputs Updated MIL-STD-461F CS114 standards compliance to "pass"	6 14
1.3	08/12/20	Updated terminology	15
1.4	06/30/21	Expanded input voltage range Removed B and 001 options Added signal characteristics, signal pin functions, typical external circuits, card edge temperature sensors, fault operation, parallel operation, standalone operation sections Updated I ² C sensor commands section Updated sensor thresholds	1, 5 4 8 – 9, 14 – 17 21 – 25 27
1.5	08/26/21	Typo correction for 0x90 Byte 0 Updated sensor thresholds for sensors 25 – 28, added sensor 33	23 27
1.6	04/23/25	Updated connector pin descriptions Updated electrical characteristics Removed example data table Revised IPMI tables	3 5, 6 24 25, 26

Contact Us: <http://www.vicorpower.com/contact-us>

Vicor Corporation

25 Frontage Road
Andover, MA, USA 01810
Tel: 800-735-6200
Fax: 978-475-6715
www.vicorpower.com

email

Customer Service: custserv@vicorpower.com
Technical Support: apps@vicorpower.com

©2018 – 2025 Vicor Corporation. All rights reserved. The Vicor name is a registered trademark of Vicor Corporation.
OpenVPX™ is a trademark of VITA.

All other trademarks, product names, logos and brands are property of their respective owners.